

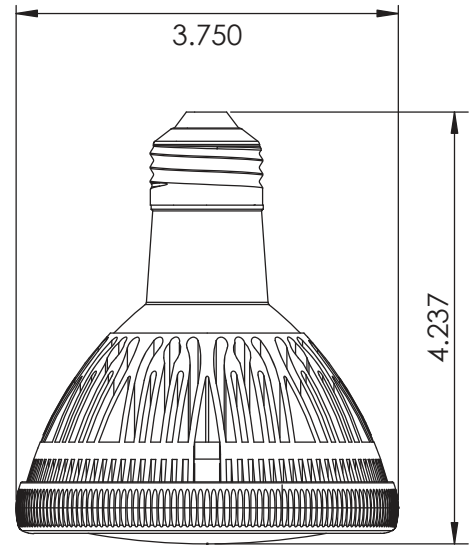

# Ambient Series LED Medium Base Lamps - PAR30

Patent Pending



Weight: 361.8 g

## General Info

### Construction

Proprietary heat management system.  
Dry location certification from ETL.

### LED Board

13W power consumption  
610lm light output.  
CRI: 80 - 85

### Optics

Multiple lens options to interchange easily.

### Ambient ID:

#205 Replicates incandescent.  
#206 Replicates Halogen.

### Mounting Mechanism

Dimmable option available. Dims down to 7%.  
Screws into existing 120 VAC Par30 sockets.  
Meets ANSI # ANSI ANSLG C78.43-2007.  
Fits in 100% of all Par30 applications.

### Serviceability

Light fixture can be easily removed and serviced.  
LED board and driver easily replaceable.  
**Suitable for use in enclosed and open fixtures.**  
5 year limited warranty (see warranty statement for further details).  
IC rated.

### Power Requirements

Phoster Light Engine takes an input of 120 VAC.  
Maintains uniformity of LED brightness and color.

Catalog    Wattage    Fixture    Lens    LED Color    Ambient ID

**P L E - 1 3 W - P 3 0 A N D - 9 D - 2 7 K - 2 0 5**

P30ND	9 Deg	205
Non-Dimmable	16 Deg	206
P30D	24 Deg	
Dimmable	36 Deg	

# LED Medium Base Lamps - PAR30 Ambient Modular Design

## Par30 - Modular View

ITEM NO.	PART NAME
1	PAR30 - Heat Sink Cover
2	Primary - Secondary Lens
3	LED Board
4	Heat Sink
5	Driver

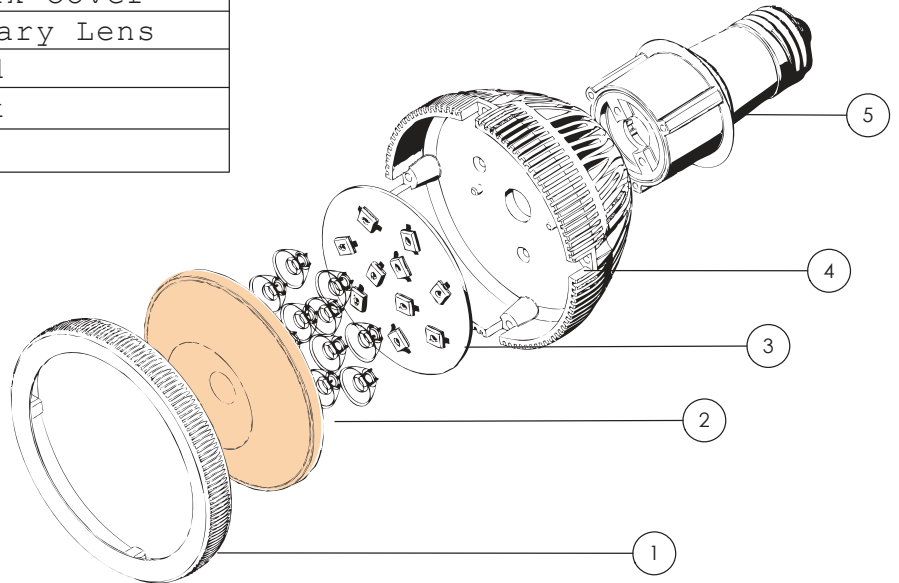

## Photometrics

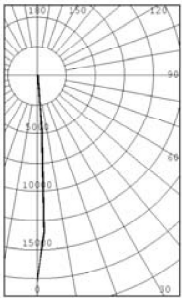

**CBCP**  
17658 Cd  
9° Optics

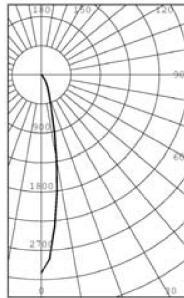

**CBCP**  
3047Cd  
24° Optics

**Illuminance at a Distance**

Center Beam FC	Field Width
6.0ft: 490.5 fc	1.5ft
8.0ft: 275.9 fc	2.0ft
10.0ft: 176.6 fc	2.5ft
12.0ft: 122.6 fc	3.0ft
14.0ft: 90.1 fc	3.5ft
16.0ft: 69.0 fc	4.0ft

Field Spread: 14.3°

**Illuminance at a Distance**

Center Beam FC	Field Width
6.0ft: 84.6 fc	4.7ft
8.0ft: 47.6 fc	6.3ft
10.0ft: 30.5 fc	7.9ft
12.0ft: 21.2 fc	9.5ft
14.0ft: 15.5 fc	11.1ft
16.0ft: 11.9 fc	12.6ft

Field Spread: 43.1°

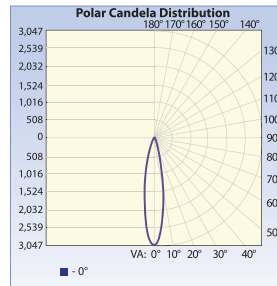
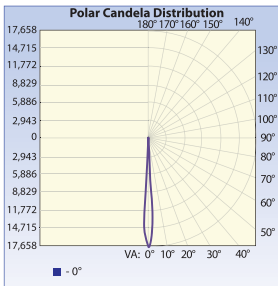

## Installation Diagram

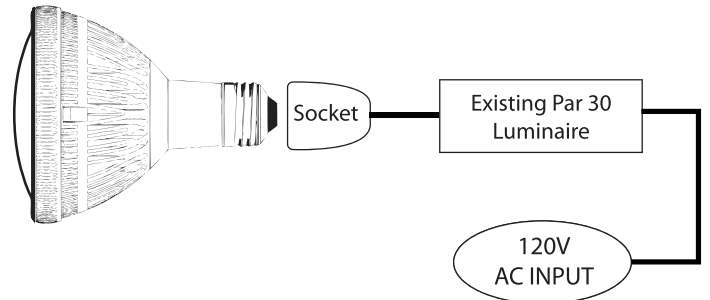

Available From:

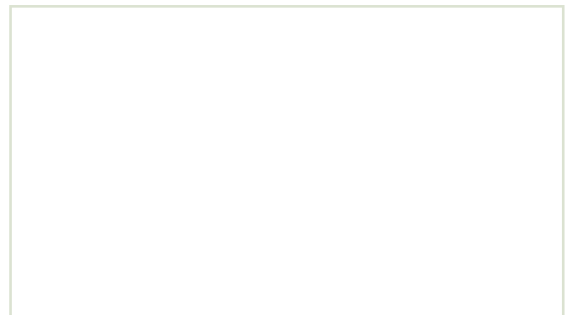

The information contained in this document is intended only for the use of the recipient. It may contain confidential, proprietary or legally privileged information. If the reader of this document is not the intended recipient, or the employee or agent responsible to deliver it to the intended recipient, you are hereby notified that any dissemination, distribution, disclosure, use, print or copying of this communication and any attachment(s) is strictly prohibited. Phoster Industries 8509 Place Devonshire, Mount-Royal, Quebec, Canada www.phosterindustries.com 11/12