

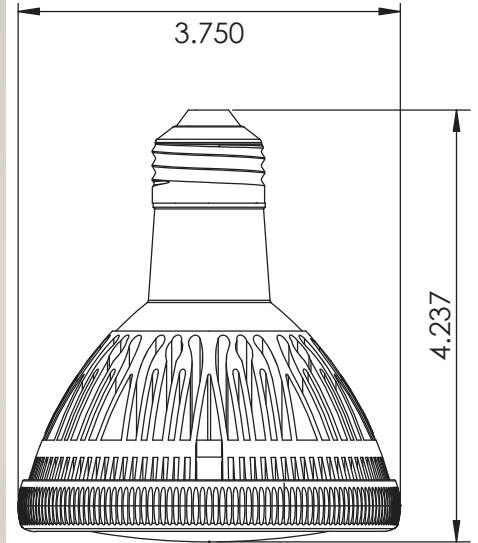

Patent Pending

# LED Medium Base Lamps - PAR30



Weight: 361.8 g

## General Info

### Construction

Proprietary heat management system.  
Dry location certification from ETL.

### LED Board

13W power consumption  
610lm light output.  
CRI: 80 - 85

### Optics

Multiple lens options to interchange easily.

### Mounting Mechanism

Dimmable option available. Dims down to 7%.  
Screws into existing 120 VAC Par30 sockets.  
Meets ANSI # ANSI ANSLG C78.43-2007.  
Fits in 100% of all Par30 applications.

### Serviceability

Light fixture can be easily removed and serviced.  
LED board and driver easily replaceable.  
**Suitable for use in enclosed and open fixtures.**  
5 year limited warranty (see warranty statement for further details).  
IC rated.

### Power Requirements

Phoster Light Engine takes an input of 120 VAC.  
Maintains uniformity of LED brightness and color.

Catalog    Wattage    Fixture    Lens    LED Color

**P L E - 1 3 W - P 3 0 N D - 9 D - 2 7 K**

P30ND	9 Deg	2700K
Non-Dimmable	16 Deg	3000K
p30D	24 Deg	3500K
Dimmable	36 Deg	4000K
		5000K

# LED Medium Base Lamps - PAR30 Modular Design

## Par30 - Modular View

ITEM NO.	PART NAME
1	PAR30 - Heat Sink Cover
2	Primary - Secondary Lens
3	LED Board
4	Heat Sink
5	Driver

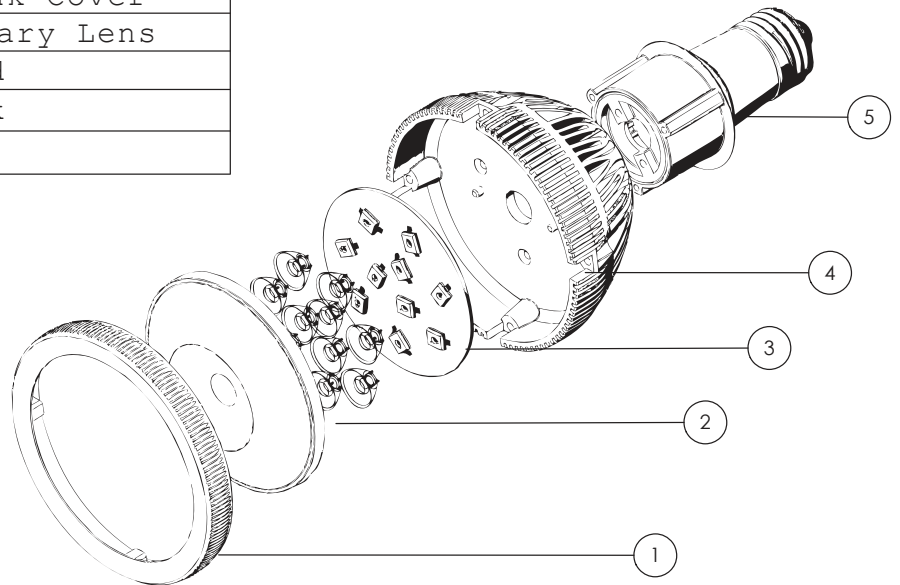

## Photometrics

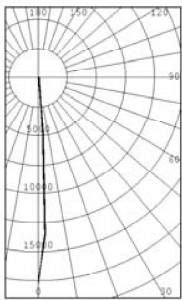

**CBCP**  
17658 Cd  
9° Optics

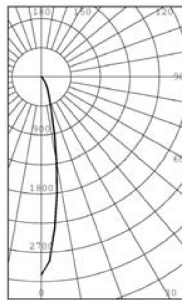

**CBCP**  
3047Cd  
24° Optics

**Illuminance at a Distance**

Center Beam FC	Field Width
6.0ft	490.5 fc
8.0ft	275.9 fc
10.0ft	176.6 fc
12.0ft	122.6 fc
14.0ft	90.1 fc
16.0ft	69.0 fc

Field Spread: 14.3°

**Illuminance at a Distance**

Center Beam FC	Field Width
6.0ft	84.6 fc
8.0ft	47.6 fc
10.0ft	30.5 fc
12.0ft	21.2 fc
14.0ft	15.5 fc
16.0ft	11.9 fc

Field Spread: 43.1°

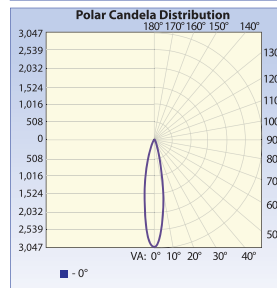
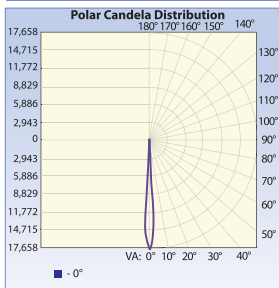

## Installation Diagram

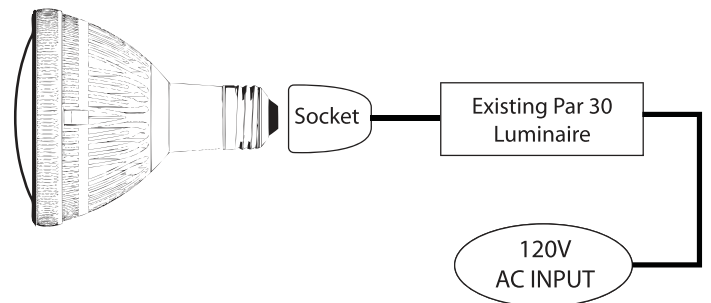

Available From:

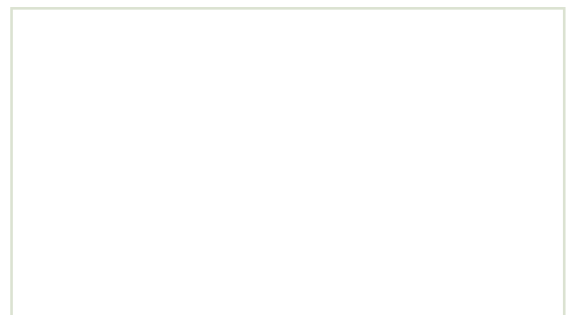

The information contained in this document is intended only for the use of the recipient. It may contain confidential, proprietary or legally privileged information. If the reader of this document is not the intended recipient, or the employee or agent responsible to deliver it to the intended recipient, you are hereby notified that any dissemination, distribution, disclosure, use, print or copying of this communication and any attachment(s) is strictly prohibited. Phoster Industries 8509 Place Devonshire, Mount-Royal, Quebec, Canada www.phosterindustries.com 11/12